

INFORMATION | MANUALS | SERVICE

Akku-Rasenmäher

Akku-Rasenmäher Comfort 38.4 Li

Montageanleitung



© 2014

AL-KO KOBER GROUP Kötz, Germany

This documentation or excerpts therefrom may not be reproduced or disclosed to third parties without the express permission of the AL-KO KOBER GROUP.

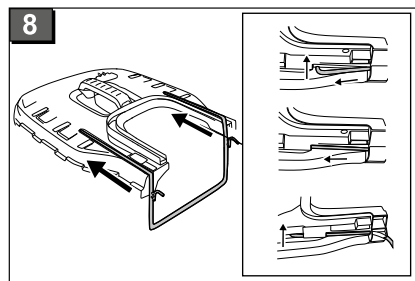
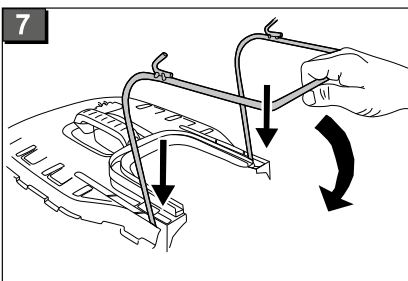
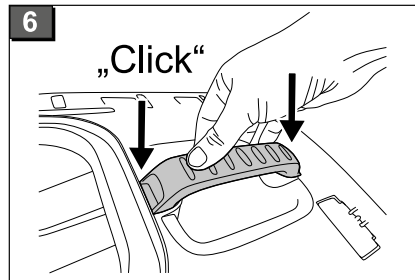
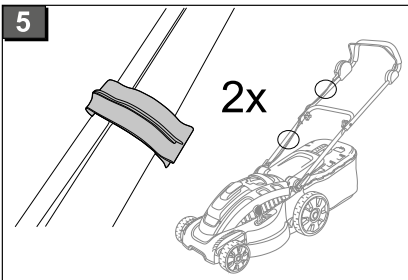
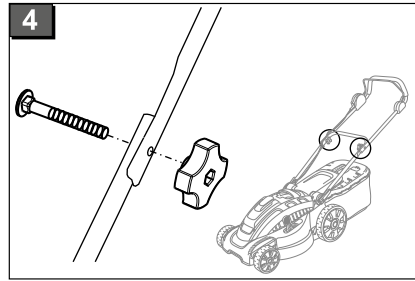
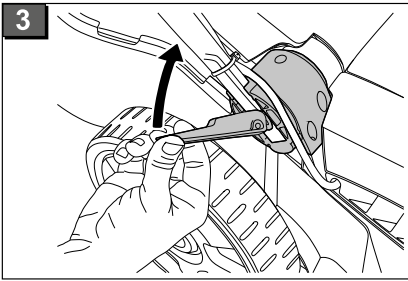
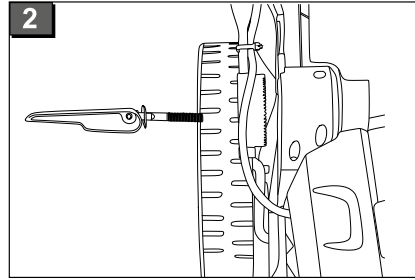
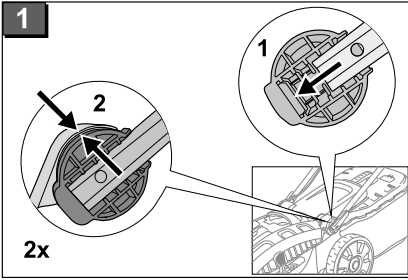

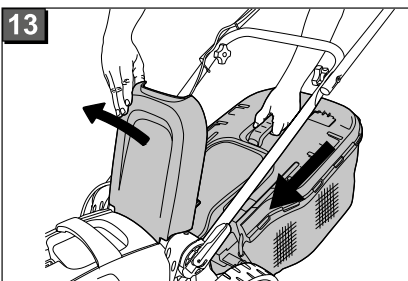
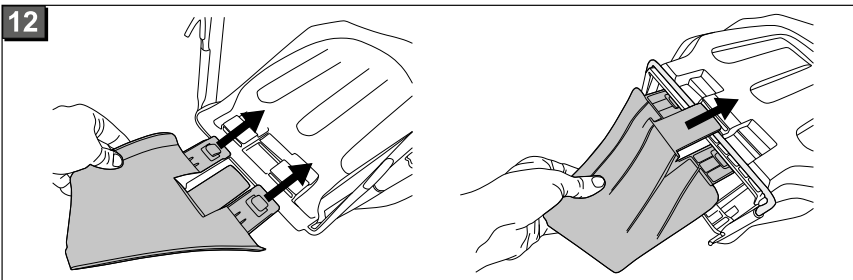
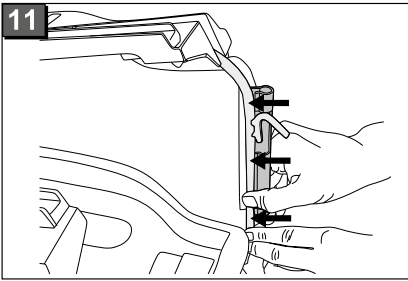
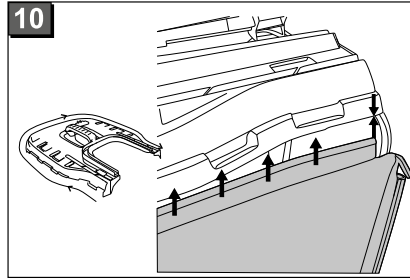
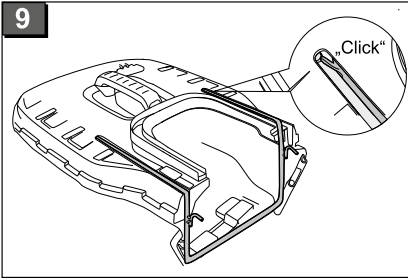

EG-KONFORMITÄTSERKLÄRUNG

Hiermit erklären wir, dass dieses Produkt in der von uns in Verkehr gebrachten Ausführung, den Anforderungen der harmonisierten EU-Richtlinien, EU-Sicherheitsstandards und den produktspezifischen Standards entspricht.

Produkt Akku-Rasenmäher	Hersteller AL-KO Geräte GmbH Ichenhauser Str. 14 D-89359 Kötz	Bevollmächtigter Andreas Hedrich Ichenhauser Str. 14 D-89359 Kötz
Seriennummer G1511515		
Typ Comfort 38.4 Li	EU-Richtlinien 2006/42 EG 2004/108/EG 2000/14/EG 2011/65/EG	Harmonisierte Normen EN 60335-1 EN 60335-2-77 EN 50338 EN 60335
Schalleistungspegel EN ISO 3744 gemessen / garantiert Comfort 38.4 Li 95 dB(A) / 96 dB(A)		

Konformitätsbewertung

2000/14/EG

Anhang VI

Benannte Stelle**INTERTEK TESTING & CERTIFICATION LTD**Intertek House, Cleeve Road
Leatherhead, Surrey KT22 7SB

Country: United Kingdom

Notified Body number : 0359

Kötz, 2013-09-12

Wolfgang Hergeth
Managing Director

EC DECLARATION OF CONFORMITY

We herewith declare that this product, with the design we have introduced on the market, meets the requirements of the harmonized EC guidelines, EC safety standards and the standards applicable to this product.

Product

Battery-operated lawn mower

Serial number

G1511515

Type

Comfort 38.4 Li

Acoustic power level

EN ISO 3744

measured / guaranteed

Comfort 38.4 Li 95 dB(A) / 96 dB(A)

Manufacturer

AL-KO Geräte GmbH
Ichenhauser Str. 14
D-89359 Kötz

EC guidelines

2006/42 EG
2004/108/EG
2000/14/EG
2011/65/EG

CE marking

2000/14/EG
Anhang VI

Official agency**INTERTEK TESTING & CERTIFICATION LTD**

Intertek House, Cleeve Road
Leatherhead, Surrey KT22 7SB
Country: United Kingdom
Notified Body number : 0359

Authorized agent

Andreas Hedrich
Ichenhauser Str. 14
D-89359 Kötz

Harmonized standards

EN 60335-1
EN 60335-2-77
EN 50338
EN 60335

Kötz, 2013-09-12



Wolfgang Hergeth
Managing Director

EG-CONFORMITEITSVERKLARING

Hierbij verklaren wij dat dit product, in de door ons op de markt gebrachte uitvoering, voldoet aan de eisen van de geharmoniseerde EG-richtlijnen, EG-veiligheidsnormen en de productspecifieke normen.

Product Accumaaiër	Fabrikant AL-KO Geräte GmbH Ichenhauser Str. 14 D-89359 Kötz	Gevolmachtigde Andreas Hedrich Ichenhauser Str. 14 D-89359 Kötz
Serienummer G1511515		Geharmoniseerde normen EN 60335-1 EN 60335-2-77 EN 50338 EN 60335
Type Comfort 38.4 Li	EG-richtlijnen 2006/42/EG 2004/108/EG 2000/14/EG 2011/65/EG	
Geluidsvermogensniveau EN ISO 3744 gemeten / gegarandeerd Comfort 38.4 Li 95 dB(A) / 96 dB(A)		

Conformiteitsbeoordeling

2000/14/EG

Anhang VI

Aangewezen instantie**INTERTEK TESTING & CERTIFICATION LTD**Intertek House, Cleeve Road
Leatherhead, Surrey KT22 7SB

Country: United Kingdom

Notified Body number : 0359

Kötz, 2013-09-12

Wolfgang Hergeth
Managing Director

DÉCLARATION DE CONFORMITÉ CE

Nous déclarons par la présente que ce produit, sous la forme mise en circulation par nos services, satisfait aux exigences des directives CE harmonisées, aux normes de sécurité CE, et aux normes spécifiques au produit.

Produit

Tondeuse à gazon à batterie

Numéro de série

G1511515

Type

Comfort 38.4 Li

Niveau sonore

EN ISO 3744

sonoremesuré / garanti

Comfort 38.4 Li 95 dB(A) / 96 dB(A)

Fabricant

AL-KO Geräte GmbH
Ichenhauser Str. 14
D-89359 Kötz

Directives CE

2006/42 EG
2004/108/EG
2000/14/EG
2011/65/EG

Evaluation de la conformité

2000/14/EG
Anhang VI

Organisme notifié**INTERTEK TESTING & CERTIFICATION LTD**

Intertek House, Cleeve Road
Leatherhead, Surrey KT22 7SB
Country: United Kingdom
Notified Body number : 0359

Fondé de pouvoir

Andreas Hedrich
Ichenhauser Str. 14
D-89359 Kötz

Normes harmonisées

EN 60335-1
EN 60335-2-77
EN 50338
EN 60335

Kötz, 2013-09-12



Wolfgang Hergeth
Managing Director

DECLARACIÓN DE CONFORMIDAD DE LA CE

Por la presente declaramos que la versión de este producto facilitada por nosotros cumple con los requisitos de las directivas europeas armonizadas, las normas de seguridad europeas y de las normas específicas del producto.

Producto Cortacésped eléctrico	Fabricante AL-KO Geräte GmbH Ichenhauser Str. 14 D-89359 Kötz	Apoderado Andreas Hedrich Ichenhauser Str. 14 D-89359 Kötz
Número de serie G1511515		
Modelo Comfort 38.4 Li	Directivas europeas 2006/42/EG 2004/108/EG 2000/14/EG 2011/65/EG	Normas armonizadas EN 60335-1 EN 60335-2-77 EN 50338 EN 60335
Nivel de potencia acústica EN ISO 3744 sonoramedido /garantizado Comfort 38.4 Li 95 dB(A) / 96 dB(A)		

Evaluación de conformidad

2000/14/EG

Anhang VI

Organismo designado**INTERTEK TESTING & CERTIFICATION LTD**Intertek House, Cleeve Road
Leatherhead, Surrey KT22 7SB

Country: United Kingdom

Notified Body number : 0359

Kötz, 2013-09-12

Wolfgang Hergeth
Managing Director

DECLARAÇÃO DE CONFORMIDADE CE

Através desta, declaramos que este produto, no modelo por nós colocado em operação, corresponde aos requisitos das directivas CE harmonizadas, padrões de segurança CE e aos padrões específicos do produto.

Produto

Corta-relvas sem fio

Número de série

G1511515

FabricanteAL-KO Geräte GmbH
Ichenhauser Str. 14
D-89359 Kötz**Mandatário**Andreas Hedrich
Ichenhauser Str. 14
D-89359 Kötz**Tipo**

Comfort 38.4 Li

Directivas CE2006/42 EG
2004/108/EG
2000/14/EG
2011/65/EG**Normas harmonizadas**EN 60335-1
EN 60335-2-77
EN 50338
EN 60335**Nível de potência sonora**

EN ISO 3744

medido / garantido

Comfort 38.4 Li 95 dB(A) / 96 dB(A)

Avaliação da conformidade2000/14/EG
Anhang VI**Ponto mencionado****INTERTEK TESTING & CERTIFICATION LTD**Intertek House, Cleeve Road
Leatherhead, Surrey KT22 7SB
Country: United Kingdom
Notified Body number : 0359

Kötz, 2013-09-12

Wolfgang Hergeth
Managing Director

DICHIARAZIONE DI CONFORMITÀ CE

Con la presente si dichiara che questo prodotto, nella versione da noi messa in commercio, è conforme ai requisiti previsti dalle direttive CE armonizzate, agli standard di sicurezza CE e agli standard specificamente previsti per il prodotto.

Prodotto Tosaerba a batteria	Fabbricante AL-KO Geräte GmbH Ichenhauser Str. 14 D-89359 Kötz	Rappresentante Andreas Hedrich Ichenhauser Str. 14 D-89359 Kötz
Numero di serie G1511515		
Tipo Comfort 38.4 Li	Direttive CE 2006/42/EG 2004/108/EG 2000/14/EG 2011/65/EG	Norme armonizzate EN 60335-1 EN 60335-2-77 EN 50338 EN 60335
Livello di potenza sonora EN ISO 3744 misurato / garantito Comfort 38.4 Li 95 dB(A) / 96 dB(A)		

Valutazione della conformità

2000/14/EG

Anhang VI

Organismo notificato**INTERTEK TESTING & CERTIFICATION LTD**Intertek House, Cleeve Road
Leatherhead, Surrey KT22 7SB

Country: United Kingdom

Notified Body number : 0359

Kötz, 2013-09-12

Wolfgang Hergeth
Managing Director

EU IZJAVA O SKLADNOSTI

Izjavljamo, da ta izdelek, v izvedbi, ki smo jo dali v promet, ustreza pogojem usklajenih EU smernic, EU varnostnim standardom in standardom, specifičnih za izdelek.

Izdelek

Akumulatorska kosilnica za travo

Serijska številka

G15111515

Tip

Comfort 38.4 Li

Raven moči hrupa

EN ISO 3744

izmerjena / zagotovljena

Comfort 38.4 Li 95 dB(A) / 96 dB(A)

Proizvajalec

AL-KO Geräte GmbH
Ichenhauser Str. 14
D-89359 Kötz

EU direktive

2006/42 EG
2004/108/EG
2000/14/EG
2011/65/EG

Ocena skladnosti

2000/14/EG
Anhang VI

**Priglašen pristojni urad
INTERTEK TESTING & CERTIFICATION LTD**

Intertek House, Cleeve Road
Leatherhead, Surrey KT22 7SB
Country: United Kingdom
Notified Body number : 0359

Pooblaščenec

Andreas Hedrich
Ichenhauser Str. 14
D-89359 Kötz

Usklajeni standardi

EN 60335-1
EN 60335-2-77
EN 50338
EN 60335

Kötz, 2013-09-12



Wolfgang Hergeth
Managing Director

EZ - IZJAVA PROIZVOĐAČA O SUKLADNOSTI PROIZVODA

Ovime izjavljujemo da ovaj proizvod u modelu koji smo stavili na tržište odgovara zahtjevima usklađenih direktiva EZ-a, sigurnosnih normi EZ-a i normama koje se odnose na sam proizvod.

Proizvod Kosilica za travu s akumulatorom	Proizvođač AL-KO Geräte GmbH Ichenhauser Str. 14 D-89359 Kötz	Predstavnik Andreas Hedrich Ichenhauser Str. 14 D-89359 Kötz
Serijski broj G1511515		
Vrsta Comfort 38.4 Li	Direktive EZ-a 2006/42 EG 2004/108/EG 2000/14/EG 2011/65/EG	Usklađene norme EN 60335-1 EN 60335-2-77 EN 50338 EN 60335
Stupanj jačine zvuka EN ISO 3744 izmjerena / zajamčena Comfort 38.4 Li 95 dB(A) / 96 dB(A)		

Ocjena usklađenosti

2000/14/EG
Anhang VI

Obaviješteno tijelo

INTERTEK TESTING & CERTIFICATION LTD
Intertek House, Cleeve Road
Leatherhead, Surrey KT22 7SB
Country: United Kingdom
Notified Body number : 0359

Kötz, 2013-09-12



Wolfgang Hergeth
Managing Director

DEKLARACJA ZGODNOŚCI WE

Niniejszym oświadczamy, że produkt ten, w wersji wprowadzonej przez nas do obrotu odpowiada wymaganiom zharmonizowanych norm WE, standardów bezpieczeństwa WE oraz specyficznym standardom produktu.

Produkt

Akumulatorowa kosiarka do trawy

Numer seryjny

G15111515

Typ

Comfort 38.4 Li

Poziom mocy akustycznej

EN ISO 3744

zmierzony / gwarantowany

Comfort 38.4 Li 95 dB(A) / 96 dB(A)

Producent

AL-KO Geräte GmbH
Ichenhauser Str. 14
D-89359 Kötz

Dyrektyw WE

2006/42 EG
2004/108/EG
2000/14/EG
2011/65/EG

Ocena zgodności

2000/14/EG
Anhang VI

**Jednostka certyfikująca
INTERTEK TESTING & CERTIFICA-
TION LTD**

Intertek House, Cleeve Road
Leatherhead, Surrey KT22 7SB
Country: United Kingdom
Notified Body number : 0359

Upoważniony

Andreas Hedrich
Ichenhauser Str. 14
D-89359 Kötz

Normy zharmonizowane

EN 60335-1
EN 60335-2-77
EN 50338
EN 60335

Kötz, 2013-09-12



Wolfgang Hergeth
Managing Director

ИЗЈАВА ЗА УСАГЛАШЕНОСТ Е3

Овим изјављујемо да овај производ, у стању у којем смо га ми пустили у промет, одговара захтевима и усаглашеним директивама Е3, сигурносним стандардима Е3 и стандардима који су специфични за дотични производ.

Производ Косилица са акумулатором Серијски број G1511515	Произвођач AL-KO Geräte GmbH Ichenhauser Str. 14 D-89359 Kötz	Овлашћено лице Andreas Hedrich Ichenhauser Str. 14 D-89359 Kötz
Тип Comfort 38.4 Li	Директиве Е3 2006/42 EG 2004/108/EG 2000/14/EG 2011/65/EG	Усаглашене норме EN 60335-1 EN 60335-2-77 EN 50338 EN 60335
Ниво звучне снаге EN ISO 3744 измерено / загарантовано Comfort 38.4 Li 95 dB(A) / 96 dB(A)		

Процена усаглашености

2000/14/EG

Anhang VI

Наведено место**INTERTEK TESTING & CERTIFICATION LTD**Intertek House, Cleeve Road
Leatherhead, Surrey KT22 7SB

Country: United Kingdom

Notified Body number : 0359

Kötz, 2013-09-12

Wolfgang Hergeth
Managing Director

DEKLARACJA ZGODNOŚCI WE

Niniejszym oświadczamy, że produkt ten, w wersji wprowadzonej przez nas do obrotu odpowiada wymaganiom zharmonizowanych norm WE, standardów bezpieczeństwa WE oraz specyficznym standardom produktu.

Produkt

Akumulatorowa kosiarka do trawy

Numer seryjny

G15111515

Typ

Comfort 38.4 Li

Poziom mocy akustycznej

EN ISO 3744

zmierzony / gwarantowany

Comfort 38.4 Li 95 dB(A) / 96 dB(A)

Producent

AL-KO Geräte GmbH
Ichenhauser Str. 14
D-89359 Kötz

Dyrektyw WE

2006/42 EG
2004/108/EG
2000/14/EG
2011/65/EG

Ocena zgodności

2000/14/EG
Anhang VI

**Jednostka certyfikująca
INTERTEK TESTING & CERTIFICA-
TION LTD**

Intertek House, Cleeve Road
Leatherhead, Surrey KT22 7SB
Country: United Kingdom
Notified Body number : 0359

Upoważniony

Andreas Hedrich
Ichenhauser Str. 14
D-89359 Kötz

Normy zharmonizowane

EN 60335-1
EN 60335-2-77
EN 50338
EN 60335

Kötz, 2013-09-12



Wolfgang Hergeth
Managing Director

PROHLÁŠENÍ O SHODĚ ES

Tímto prohlašujeme, že tento výrobek, v provedení námi uvedeném na trh, splňuje požadavky harmonizovaných směrnic ES, bezpečnostních norem ES a norem relevantních pro daný výrobek.

Výrobek

Akumulátorová trávni sekačka

Sériové číslo

G1511515

VýrobceAL-KO Geräte GmbH
Ichenhauser Str. 14
D-89359 Kötzt**Zmocněná osoba**Andreas Hedrich
Ichenhauser Str. 14
D-89359 Kötzt**Typ**

Comfort 38.4 Li

Směrnice ES2006/42 EG
2004/108/EG
2000/14/EG
2011/65/EG**Harmonizované normy**EN 60335-1
EN 60335-2-77
EN 50338
EN 60335**Hladina akustického výkonu**

EN ISO 3744

naměřená / garantovaná

Comfort 38.4 Li 95 dB(A) / 96 dB(A)

Vyhodnocení shody2000/14/EG
Anhang VI**Jmenovaný orgán****INTERTEK TESTING & CERTIFICATION LTD**Intertek House, Cleeve Road
Leatherhead, Surrey KT22 7SB
Country: United Kingdom
Notified Body number : 0359

Kötzt, 2013-09-12

Wolfgang Hergeth
Managing Director

ES VYHLÁSENIE O ZHODE

Týmto vyhlasujeme, že tento výrobok, vo vyhotovení nami dodanom do obehu, zodpovedá požiadavkám harmonizovaných smerníc ES, bezpečnostných štandardov ES a štandardom špecifickým pre výrobok.

Výrobok

Akumulátorová kosačka na trávu

Sériové číslo

G1511515

Typ

Comfort 38.4 Li

Hladina akustického výkonu

EN ISO 3744

nameraná / zaručená

Comfort 38.4 Li 95 dB(A) / 96 dB(A)

Výrobca

AL-KO Geräte GmbH
Ichenhauser Str. 14
D-89359 Kötz

Smernice ES

2006/42 EG
2004/108/EG
2000/14/EG
2011/65/EG

Posúdenie zhody

2000/14/EG
Anhang VI

Menované miesto**INTERTEK TESTING & CERTIFICATION LTD**

Intertek House, Cleeve Road
Leatherhead, Surrey KT22 7SB
Country: United Kingdom
Notified Body number : 0359

Splnomocnená osoba

Andreas Hedrich
Ichenhauser Str. 14
D-89359 Kötz

Harmonizované normy

EN 60335-1
EN 60335-2-77
EN 50338
EN 60335

Kötz, 2013-09-12



Wolfgang Hergeth
Managing Director

EK MEGFELELŐSÉGI NYILATKOZAT

Ezennel kijelentjük, hogy ez a termék az általunk forgalomba hozott formában megfelel a harmonizált EK-irányvonalak, az EK biztonsági szabványai és a termékre vonatkozó szabványok által előírt követelményeknek.

Termék Akkumulátoros fűnyíró	Gyártó AL-KO Geräte GmbH Ichenhauser Str. 14 D-89359 Kötz	Meghatalmazott Andreas Hedrich Ichenhauser Str. 14 D-89359 Kötz
Sorozatszám G1511515		
Típus Comfort 38.4 Li	EK-irányvonalak 2006/42 EG 2004/108/EG 2000/14/EG 2011/65/EG	Harmonizált normák EN 60335-1 EN 60335-2-77 EN 50338 EN 60335
Hangteljesítményszint EN ISO 3744 mért / garantált Comfort 38.4 Li 95 dB(A) / 96 dB(A)		

Megfelelőségi értékelés

2000/14/EG
Anhang VI

Megbízott hely

INTERTEK TESTING & CERTIFICATION LTD
Intertek House, Cleeve Road
Leatherhead, Surrey KT22 7SB
Country: United Kingdom
Notified Body number : 0359

Kötz, 2013-09-12



Wolfgang Hergeth
Managing Director

EU-OVERENSSTEMMELSESERKLÆRING

Vi erklærer hermed, at dette produkt, som vi har sendt på markedet, overholder kravene i de harmoniserede EU-direktiver, EU's sikkerhedsstandarder og de produktspecifikke standarder.

Produkt

Batteridrevet græsslåmaskine

Serienummer

G1511515

Model

Comfort 38.4 Li

Lydniveau

EN ISO 3744

målt / garanteret

Comfort 38.4 Li 95 dB(A) / 96 dB(A)

Producent

AL-KO Geräte GmbH
Ichenhauser Str. 14
D-89359 Kötz

EG-direktiver

2006/42 EG
2004/108/EG
2000/14/EG
2011/65/EG

Overensstemmelsesvurdering

2000/14/EG
Anhang VI

Bemyndiget organ**INTERTEK TESTING & CERTIFICATION LTD**

Intertek House, Cleeve Road
Leatherhead, Surrey KT22 7SB
Country: United Kingdom
Notified Body number : 0359

Advokat

Andreas Hedrich
Ichenhauser Str. 14
D-89359 Kötz

Harmoniserede standarder

EN 60335-1
EN 60335-2-77
EN 50338
EN 60335

Kötz, 2013-09-12



Wolfgang Hergeth
Managing Director

EG-FÖRSÄKRAN OM ÖVERENSSTÄMMELSE

Härmed förklarar vi att denna produkt, i det av oss marknadsförda utförandet, motsvarar kraven enligt de harmoniserade EG-direktiven, EG-säkerhetsstandarderna och de produktspecifika standarderna.

Produkt

Batteridriven gräsklippare

Serienummer

G1511515

TillverkareAL-KO Geräte GmbH
Ichenhauser Str. 14
D-89359 Kötz**Befullmäktigad**Andreas Hedrich
Ichenhauser Str. 14
D-89359 Kötz**Typ**

Comfort 38.4 Li

EG-direktiv2006/42 EG
2004/108/EG
2000/14/EG
2011/65/EG**Harmoniserade normer**EN 60335-1
EN 60335-2-77
EN 50338
EN 60335**Ljudeffektnivå**

EN ISO 3744

uppmätt / garanterad

Comfort 38.4 Li 95 dB(A) / 96 dB(A)

Bedömning av överensstämmelsen

2000/14/EG

Anhang VI

Ansvarig myndighet**INTERTEK TESTING & CERTIFICA-
TION LTD**Intertek House, Cleeve Road
Leatherhead, Surrey KT22 7SB
Country: United Kingdom
Notified Body number : 0359

Kötz, 2013-09-12

Wolfgang Hergeth
Managing Director

EU-SAMSVARSERKLÆRING

Vi erklærer herved at dette produktet i denne utførelsen, oppfyller kravene i de harmoniserte EU-direktivene, EU-sikkerhetsstandardene og de produktspesifikke standardene.

Produkt

Batteridreven gråsklippare

Serienummer

G1511515

Type

Comfort 38.4 Li

Lydtrykknivå

EN ISO 3744

målt / garantert

Comfort 38.4 Li 95 dB(A) / 96 dB(A)

Produsent

AL-KO Geräte GmbH
Ichenhauser Str. 14
D-89359 Kötz

EU-direktiver

2006/42 EG
2004/108/EG
2000/14/EG
2011/65/EG

Samsvarsurdering

2000/14/EG
Anhang VI

Nevnte sted**INTERTEK TESTING & CERTIFICATION LTD**

Intertek House, Cleeve Road
Leatherhead, Surrey KT22 7SB
Country: United Kingdom
Notified Body number : 0359

Ansvarlig

Andreas Hedrich
Ichenhauser Str. 14
D-89359 Kötz

Harmoniserte normer

EN 60335-1
EN 60335-2-77
EN 50338
EN 60335

Kötz, 2013-09-12



Wolfgang Hergeth
Managing Director

EY-VAATIMUSTENMUKAISUUSVAKUUTUS

Todistamme täten, että tämä tuote, sellaisena kuin me olemme saattaneet sen markkinoille, vastaa harmonisoituja EY-direktiivejä, EY-turvastandardeja ja tuotekohtaisia standardeja.

Tuote

Akkukäyttöinen ruohonleikkuri

Sarjanumero

G1511515

ValmistajaAL-KO Geräte GmbH
Ichenhauser Str. 14
D-89359 Kötz**Valtuutettu henkilö**Andreas Hedrich
Ichenhauser Str. 14
D-89359 Kötz**Tyyppi**

Comfort 38.4 Li

EY-direktiivit2006/42 EG
2004/108/EG
2000/14/EG
2011/65/EG**Harmonisoidut normit**EN 60335-1
EN 60335-2-77
EN 50338
EN 60335**Äänen tehotaso**

EN ISO 3744

mitattu / taattu

Comfort 38.4 Li 95 dB(A) / 96 dB(A)

Vaatimustenmukaisuusarviointi2000/14/EG
Anhang VI**Ilmoitettu laitos****INTERTEK TESTING & CERTIFICATION LTD**Intertek House, Cleeve Road
Leatherhead, Surrey KT22 7SB
Country: United Kingdom
Notified Body number : 0359

Kötz, 2013-09-12

Wolfgang Hergeth
Managing Director

EÜ VASTAVUSDEKLARATSIIOON

Käesolevaga deklareerime, et see toode vastab meie poolt turuleviidud teostuses EÜ direktiivide, EÜ ohutusstandardite ja tootespetsiifiliste standardite nõuetele.

Toode

Akumuriiduk

Seerianumber

G1511515

Tootja

AL-KO Geräte GmbH
Ichenhauser Str. 14
D-89359 Kötz

Volitatud isik

Andreas Hedrich
Ichenhauser Str. 14
D-89359 Kötz

Tüüp

Comfort 38.4 Li

EÜ direktiivid

2006/42 EG
2004/108/EG
2000/14/EG
2011/65/EG

Harmoniseeritud normid

EN 60335-1
EN 60335-2-77
EN 50338
EN 60335

Müravõimsustase

EN ISO 3744

mõõdetud / tagatud

Comfort 38.4 Li 95 dB(A) / 96 dB(A)

Vastavuse hindamine

2000/14/EG
Anhang VI

Teavitatud asutus**INTERTEK TESTING & CERTIFICATION LTD**

Intertek House, Cleeve Road
Leatherhead, Surrey KT22 7SB
Country: United Kingdom
Notified Body number : 0359

Kötz, 2013-09-12



Wolfgang Hergeth
Managing Director

EK ATBILSTĪBAS DEKLARĀCIJA

Ar šo mēs apliecinām, ka minētā prece tādā izpildījumā, kādu mēs to esam laiduši apgrozībā, atbilst saskaņoto EK direktīvu prasībām, EK drošības standartiem un specifiskiem standartiem, kas attiecas uz konkrēto preci.

Prece

Zāles pļāvējs ar akumulatoru

Sērijas numurs

G1511515

RažotājsAL-KO Geräte GmbH
Ichenhauser Str. 14
D-89359 Kötz**Pilnvarotā persona**Andreas Hedrich
Ichenhauser Str. 14
D-89359 Kötz**Tips**

Comfort 38.4 Li

EK direktīvas2006/42 EG
2004/108/EG
2000/14/EG
2011/65/EG**Saskaņotie standarti**EN 60335-1
EN 60335-2-77
EN 50338
EN 60335**Skaņas jaudas līmenis**

EN ISO 3744

izmērītais / garantētais

Comfort 38.4 Li 95 dB(A) / 96 dB(A)

Atbilstības novērtējums2000/14/EG
Anhang VI**Pilnvarotā iestāde****INTERTEK TESTING & CERTIFICATION LTD**Intertek House, Cleeve Road
Leatherhead, Surrey KT22 7SB
Country: United Kingdom
Notified Body number : 0359

Kötz, 2013-09-12

Wolfgang Hergeth
Managing Director

EB ATITIKTIES DEKLARACIJA

Šiuo pareiškime, kad mūsų šios konstrukcijos išleistas gaminys, atitinka suderintas EB direktyvas, EB saugumo standartus ir gaminiui būtinus standartus.

Gaminys

Akumuliatorinė vejapjovė

Serijos numeris

G15111515

Tipas

Comfort 38.4 Li

Garso galingumas

EN ISO 3744

išmatuotas / garantuojamas

Comfort 38.4 Li 95 dB(A) / 96 dB(A)

Gamintojas

AL-KO Geräte GmbH
Ichenhauser Str. 14
D-89359 Kötz

EB Direktyvos

2006/42 EG
2004/108/EG
2000/14/EG
2011/65/EG

Atitikties įvertinimas

2000/14/EG
Anhang VI

Įgaliota įstaiga**INTERTEK TESTING & CERTIFICATION LTD**

Intertek House, Cleeve Road
Leatherhead, Surrey KT22 7SB
Country: United Kingdom
Notified Body number : 0359

Įgaliotasis asmuo

Andreas Hedrich
Ichenhauser Str. 14
D-89359 Kötz

Suderintos normos

EN 60335-1
EN 60335-2-77
EN 50338
EN 60335

Kötz, 2013-09-12



Wolfgang Hergeth
Managing Director

ДЕКЛАРАЦИЯ СООТВЕТСТВИЯ СТАНДАРТАМ ЕС

Настоящим мы заявляем, что данное изделие в исполнении, запущенном нами в обращение, соответствует требованиям согласованных директив ЕС, стандартов безопасности ЕС и специфичных для изделия стандартов.

Изделие	Производитель	Уполномоченное лицо
Аккумуляторная газонокосилка		
Серийный номер G1511515	AL-KO Geräte GmbH Ichenhauser Str. 14 D-89359 Kötz	Andreas Hedrich Ichenhauser Str. 14 D-89359 Kötz
Тип Comfort 38.4 Li	Директивы ЕС 2006/42 EG 2004/108/EG 2000/14/EG 2011/65/EG	Согласованные стандарты EN 60335-1 EN 60335-2-77 EN 50338 EN 60335
Уровень мощности шума EN ISO 3744 измеренный / гарантируемый Comfort 38.4 Li 95 dB(A) / 96 dB(A)		

Оценка соответствия

2000/14/EG
Anhang VI

Уполномоченный орган
INTERTEK TESTING & CERTIFICATION LTD

Intertek House, Cleeve Road
Leatherhead, Surrey KT22 7SB
Country: United Kingdom
Notified Body number : 0359

Kötz, 2013-09-12



Wolfgang Hergeth
Managing Director

ДЕКЛАРАЦІЯ ВІДПОВІДНОСТІ СТАНДАРТАМ ЄС

Ми заявляємо, що даний виріб у виконанні, яке запущене нами в оборот, відповідає вимогам узгоджених директив ЄС, стандартів безпеки ЄС та специфічних для виробу стандартів.

Виріб Акумуляторна газонокосарка	Виробник AL-KO Geräte GmbH Ichenhauser Str. 14 D-89359 Kötz	Уповноважена особа Andreas Hedrich Ichenhauser Str. 14 D-89359 Kötz
Серійний номер G1511515		
Тип Comfort 38.4 Li	Директиви ЄС 2006/42 EG 2004/108/EG 2000/14/EG 2011/65/EG	Узгоджені стандарти EN 60335-1 EN 60335-2-77 EN 50338 EN 60335
Рівень потужності шуму EN ISO 3744 обмірюваний / гарантований Comfort 38.4 Li 95 dB(A) / 96 dB(A)		

Оцінка відповідності

2000/14/EG

Anhang VI

**Уповноважений орган
INTERTEK TESTING & CERTIFICA-
TION LTD**

Intertek House, Cleeve Road
Leatherhead, Surrey KT22 7SB
Country: United Kingdom
Notified Body number : 0359

Kötz, 2013-09-12



Wolfgang Hergeth
Managing Director

ДЕКЛАРАЦИЯ ЗА СЪОТВЕТСТВИЕ „ЕО“

С настоящото декларираме, че този продукт, в пуснатата от нас в реализация изработка, съответства на изискванията на хармонизираните директиви на ЕО, стандартите за безопасност на ЕО и специфичните за продукта стандарти.

Продукт	Производител	Упълномощен представител
Акумулаторна косачка		
Сериен номер G1511515	AL-KO Geräte GmbH Ichenhauser Str. 14 D-89359 Kötz	Andreas Hedrich Ichenhauser Str. 14 D-89359 Kötz
Тип Comfort 38.4 Li	Директиви на ЕО 2006/42 EG 2004/108/EG 2000/14/EG 2011/65/EG	Хармонизирани стандарти EN 60335-1 EN 60335-2-77 EN 50338 EN 60335
Ниво на силата на звука EN ISO 3744 измерено / гарантирано Comfort 38.4 Li 95 dB(A) / 96 dB(A)		

Оценка на съответствието

2000/14/EG
Anhang VI

Нотифициран орган

INTERTEK TESTING & CERTIFICATION LTD
Intertek House, Cleeve Road
Leatherhead, Surrey KT22 7SB
Country: United Kingdom
Notified Body number : 0359

Kötz, 2013-09-12



Wolfgang Hergeth
Managing Director

DECLARAȚIE DE CONFORMITATE CE

Prin prezenta declarăm că acest produs, în varianta pusă în circulație de către firma noastră corespunde cerințelor directivelor CE armonizate, standardelor CE privind siguranța și standardelor specifice produsului.

Produs

Mașină de tuns gazonul cu acumulator

Seria

G15111515

Tip

Comfort 38.4 Li

Nivelul de presiune a sunetului

EN ISO 3744

evaluat / garantat

Comfort 38.4 Li 95 dB(A) / 96 dB(A)

Producător

AL-KO Geräte GmbH
Ichenhauser Str. 14
D-89359 Kötz

Directive CE

2006/42 EG
2004/108/EG
2000/14/EG
2011/65/EG

Evaluarea conformității

2000/14/EG
Anhang VI

Organismul notificat**INTERTEK TESTING & CERTIFICATION LTD**

Intertek House, Cleeve Road
Leatherhead, Surrey KT22 7SB
Country: United Kingdom
Notified Body number : 0359

Împuternicit

Andreas Hedrich
Ichenhauser Str. 14
D-89359 Kötz

Standarde armonizate

EN 60335-1
EN 60335-2-77
EN 50338
EN 60335

Kötz, 2013-09-12



Wolfgang Hergeth
Managing Director

ΔΗΛΩΣΗ ΣΥΜΜΟΡΦΩΣΗΣ ΕΚ

Δια του παρόντος δηλώνουμε ότι το προϊόν αυτό, στην έκδοση που κυκλοφορεί από την εταιρεία μας στην αγορά, πληροί τις απαιτήσεις των εναρμονισμένων Κοινοτικών Οδηγιών, των Κοινοτικών Προτύπων ποιότητας και των ειδικών για το προϊόν προτύπων.

Προϊόν

Χλοοκοπτική μηχανή μπαταρίας

Αριθμός σειράς

G1511515

Κατασκευαστής

AL-KO Geräte GmbH
Ichenhauser Str. 14
D-89359 Kötz

Πληρεξούσιος

Andreas Hedrich
Ichenhauser Str. 14
D-89359 Kötz

Τύπος

Comfort 38.4 Li

Κοινοτικές Οδηγίες

2006/42 EG
2004/108/EG
2000/14/EG
2011/65/EG

Εναρμονισμένα πρότυπα

EN 60335-1
EN 60335-2-77
EN 50338
EN 60335

Ηχοστάθμη

EN ISO 3744

μετρηθείσα / εγγυημένη

Comfort 38.4 Li 95 dB(A) / 96 dB(A)

Αξιολόγηση συμμόρφωσης

2000/14/EG
Anhang VI

Κοινοποιημένος φορέας

**INTERTEK TESTING & CERTIFICA-
TION LTD**
Intertek House, Cleeve Road
Leatherhead, Surrey KT22 7SB
Country: United Kingdom
Notified Body number : 0359

Kötz, 2013-09-12



Wolfgang Hergeth
Managing Director

ИЗЈАВА ЗА УСОГЛАСЕНОСТ ЗА ЕУ

Со ова изјавуваме дека овој производ, во изведбата која ние сме ја пуштиле во промет, ги задоволува барањата на хармонизираните директиви на ЕУ, безбедносните стандарди на ЕУ и на стандардите кои се специфични за самиот производ.

Производ

Косилка за трева со акумулатор

Сериски број

G1511515

ПроизводителAL-KO Geräte GmbH
Ichenhauser Str. 14
D-89359 Kötz**Овластено лице**Andreas Hedrich
Ichenhauser Str. 14
D-89359 Kötz**Тип**

Comfort 38.4 Li

Директиви на ЕУ2006/42 EG
2004/108/EG
2000/14/EG
2011/65/EG**Хармонизирани норми**EN 60335-1
EN 60335-2-77
EN 50338
EN 60335**Ниво на јачината на звукот**

EN ISO 3744

gemessen / garantiert

Comfort 38.4 Li 95 dB(A) / 96 dB(A)

Проценка на усогласеност2000/14/EG
Anhang VI**Назначено место****INTERTEK TESTING & CERTIFICATION LTD**Intertek House, Cleeve Road
Leatherhead, Surrey KT22 7SB
Country: United Kingdom
Notified Body number : 0359

Kötz, 2013-09-12

Wolfgang Hergeth
Managing Director

AB UYGUNLUK BEYANI

İşbu beyanla, bu ürünün, tarafımızdan kullanıma sunulan modeliyle, uyumlu AB Yönetmelikleri, AB Güvenlik Standartları, ve ürüne özel standartların istemlerine uygun olduğunuz beyan ederiz.

Ürün

Akülü çim biçme makinesi

Seri numarası

G1511515

ÜreticiAL-KO Geräte GmbH
Ichenhauser Str. 14
D-89359 Kötz**Vekil**Andreas Hedrich
Ichenhauser Str. 14
D-89359 Kötz**Tip**

Comfort 38.4 Li

AB Yönetmelikleri2006/42 EG
2004/108/EG
2000/14/EG
2011/65/EG**Uyumlu normlar**EN 60335-1
EN 60335-2-77
EN 50338
EN 60335**Ses çıkış seviyesi**

EN ISO 3744

ölçülen / garanti edilen

Comfort 38.4 Li 95 dB(A) / 96 dB(A)

Uygunluk değerlendirmesi2000/14/EG
Anhang VI**Belirtilen merkez****INTERTEK TESTING & CERTIFICA-
TION LTD**
Intertek House, Cleeve Road
Leatherhead, Surrey KT22 7SB
Country: United Kingdom
Notified Body number : 0359

Kötz, 2013-09-12

Wolfgang Hergeth
Managing Director

COMFORT 38.4 LI

Art.Nr. 113 124

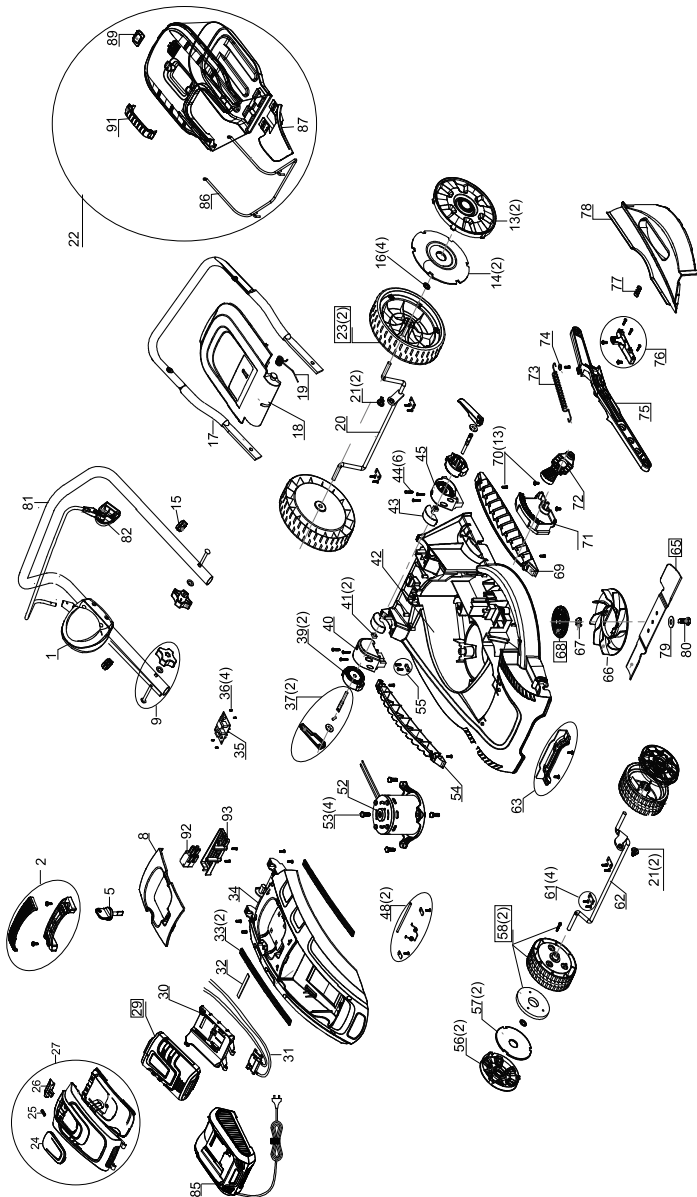

COMFORT 38.4 LI**Art.Nr. 113 124**

Pos.	Art.-Nr.		Pos.	Art.-Nr.
1	441087		57	413861
2	413821		58	413862
5	413822		60	413863
8	413823		61	413864
9	413824		62	413865
13	413825		63	413866
14	413826		65	413867
15	413827		66	413868
16	413828		67	413869
17	413829		68	413870
18	413830		69	413871
19	413831		70	413872
20	413832		71	413873
21	413833		72	413874
22	413834		73	413875
23	413835		74	413876
24	413836		75	413877
25	413837		76	413878
26	413838		77	413879
27	413839		78	413880
29	113126		79	413881
30	413840		80	413882
31	413841		81	413883
32	413842		82	413884
33	413843		85	413885
34	413844		86	413886
35	413845		87	413887
36	413846		89	413888
37	413847		91	413889
39	413848		92	414825
40	413849		93	414826
41	413850			
42	413851			
43	413852			
44	413853			
45	413854			
48	413855			
52	413856			
53	413857			
54	413858			
55	413859			
56	413860			

COMFORT 38.4 LI MIT ZUSATZAKKU

Art.Nr. 113 125

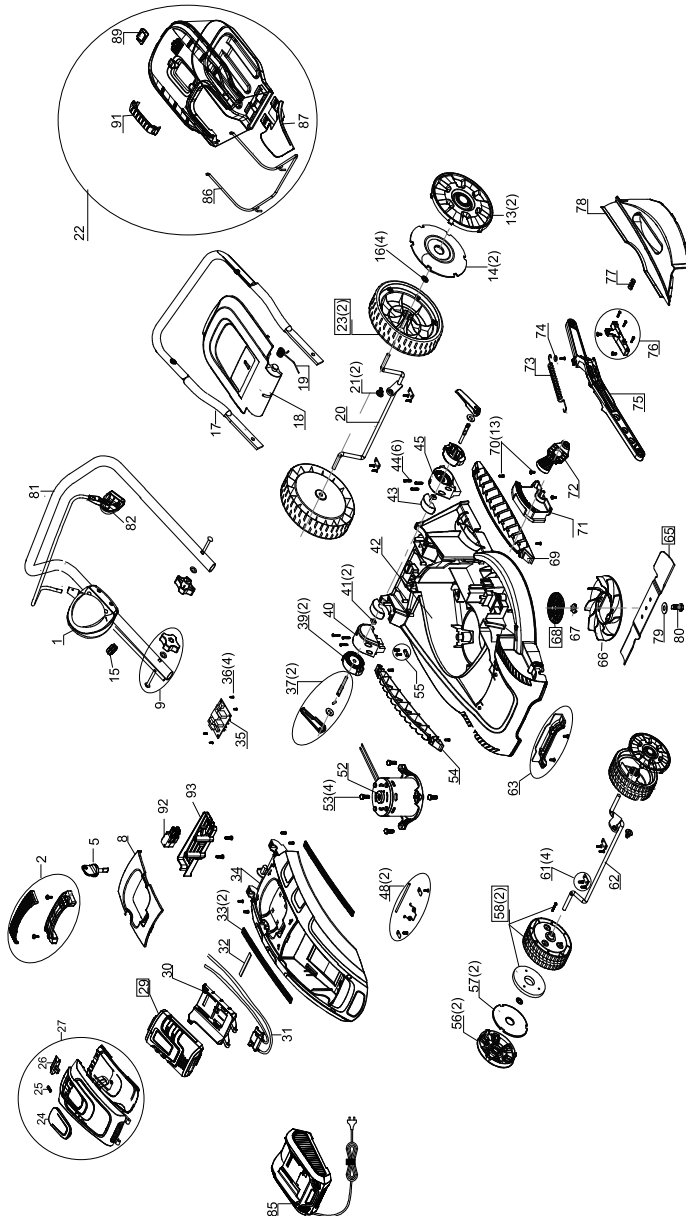

COMFORT 38.4 LI MIT ZUSATZAKKU

Art.Nr. 113 125

Pos.	Art.-Nr.		Pos.	Art.-Nr.
1	441087		57	413861
2	413821		58	413862
5	413822		60	413863
8	413823		61	413864
9	413824		62	413865
13	413825		63	413866
14	413826		65	413867
15	413827		66	413868
16	413828		67	413869
17	413829		68	413870
18	413830		69	413871
19	413831		70	413872
20	413832		71	413873
21	413833		72	413874
22	413834		73	413875
23	413835		74	413876
24	413836		75	413877
25	413837		76	413878
26	413838		77	413879
27	413839		78	413880
29	113126		79	413881
30	413840		80	413882
31	413841		81	413883
32	413842		82	413884
33	413843		85	413885
34	413844		86	413886
35	413845		87	413887
36	413846		89	413888
37	413847		91	413889
39	413848		92	414825
40	413849		93	414826
41	413850			
42	413851			
43	413852			
44	413853			
45	413854			
48	413855			
52	413856			
53	413857			
54	413858			
55	413859			
56	413860			

Country	Company	Telephone	Fax
A	AL-KO KOBER Ges.m.b.H.	(+43)3578/2515-100	(+43)3578/2515-31
AUS	AL-KO INTERNATIONAL Pty. Ltd.	(+61)3/9767-3700	(+61)3/9767-3799
B / L	Eurogarden NV	(+32)16/805427	(+32)16/805425
BG	Valerii S&M Group SJ	(+359)2 942 34 02	(+359)2 942 34 10
CH	AL-KO KOBER AG	(+41)56/418-31 53	(+41)56/4183160
CZ	AL-KO KOBER Spol. S.R.O.	(+420)382/210381	(+420)382/212782
D	AL-KO GERÄTE GmbH	(+49)8221/203-0	(+49)8221/97-8199
DK	AL-KO GINGE A/S	(+45)98821000	(+45)98825454
EST/LT/LV	SIA AL-KO KOBER	(+371)67/627-326	((+371)67/807-018
F	AL-KO S.A.S.	(+33)3/8576-3500	(+33)3/8576-3581
GB	Rochford Garden Machinery Ltd.	(+44)1963/828050	(+44)1963/828052
H	AL-KO KFT	(+36)29/5370-50	(+36)29/5370-51
HR	Brun.ko.-prom d.o.o.	(+385)1 3096 567	(+385)1 3096 567
I	AL-KO KOBER GmbH / SRL	(+39)039/9329-311	(+39)039/9329-390
IN	AGRO-COMMERCIAL	(+91)3322874206	(+91)3322874139
IQ	Avro Gulistan Com	(+946)750 450 80 64	
IRL	Cyril Johnston & Co. Ltd.	(+44)2890813121	(+44)2890914220
LY	ASHOFAN FOR AGRICULT. ACC.	(+218)512660209	(+218)512660209
MA	BADRA Sarl	(+212)022447128	(+212)022447130
MK	Techno Geneks	(+389)2 2551801	(+389)2 2520175
N	AL-KO GINGE A/S	(+47)64/86-2550	(+47)64/86-2554
NL	O.DE LEEUW GROENTECHNIEK	(+31)38/444 6160	(+31)38/444 6358
PL	AL-KO KOBER Sp. z.o.o.	(+48)61/816-1925	(+48)61/816-1980
RO	SC PECEF TEHNICA SRL	(+40)344 40 30 30	(+40)244 51 44 86
RUS	OOO AL-KO KOBER	(+7)499/16708-42	(+7)499/96600-00
RUS	ZAO AL-KO St. Petersburg GmbH	(+7)812/446-1084	(+7)812/446-1084
S	GINGE Svenska AB	(+46)31/57-3580	(+46)31/57-5620
SK	AL-KO KOBER Slovakia Spol. S.R.O.	(+421)2/4564-8267	(+421)2/4564-8117
SLO	Darko Opara s.p.	(+386)1 722 58 50	(+386)1 722 58 51
SRB	Agromarket d.o.o.	(+381)34 308 000	(+381)34 308 16
TR	ZIMAS A.S.	(+90)232 4580586	(+90)232 4572697
UA	TOV AL-KO KOBER	(+380)44/492 33-96/97	(+380)44/496 66-93